

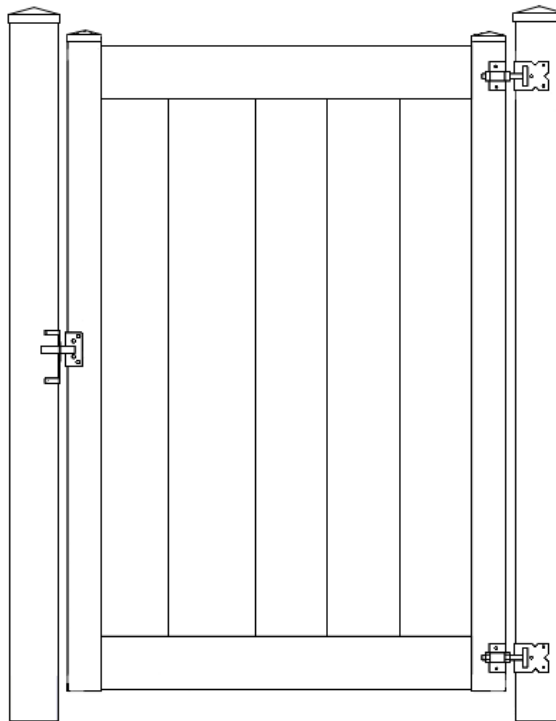

**US VINYL FENCE**  
— Fence, Deck and Rail —

# **SINGLE VINYL GATE**

## INSTALLATION INSTRUCTIONS



**WHAT YOU'LL NEED TO INSTALL A GATE WITH POSTS**

- POWER AUGER OR POST HOLE DIGGER(CLAMSHELLS)
- SHOVEL
- DIGGING BAR (OPTIONAL)
- BRIGHT COLORED SPRAY PAINT
- STRING LINE STAKES AND LEVEL
- CORDLESS OR POWER DRILL WITH DRILL AND SCREW BITS
- TAPE MEASURE
- SAFETY GLASSES AND WORK GLOVES
- PVC ADHESIVE
- RAG AND CLEANER

**HELPFULL HINTS**

- TO ENSURE PROPER POST SPACING, MAKE A JIG MEASURING THE DESIRED WIDTH OF THE GATE OPENING FROM A WOOD 2 X 4.
- IF SETTING WITH OTHER POSTS FOR SECTIONS OF FENCING SET ALL CORNER, END AND GATE POSTS FIRST FOR PROPER ALIGNMENT. THIS ALSO ALLOWS YOU TO GET THE HEIGHT ON ALL POSTS PRECISE, BY RUNNING A STRING LINE FROM POST TOP TO POST TOP.

**FOLLOW THESE IMPORTANT STEPS BEFORE YOU START:**

- Locate property lines... You can find these by locating a pin placed in the curb in the front of your house or by a stake buried in the ground or by a T post placed in the back. If you can't find any of these then try and locate a plot map. Otherwise you will have to hire a surveyor to locate your property lines.
- Check your local city codes regarding fence locations in the front of the house some cities may restrict you to a 3' or 4' height limit also check for overall fence heights in your city. A permit may be required for fences that exceed 6' in height.
- If you live in an HOA make sure to have your fence color and height approved before installing. This will save you money and possibly delays.

Contact Blue Stakes for location of utilities and pipelines. "It's The Law"

CALL 811 OR 1-800-662-4111

## Vinyl Gate

**PARTS LIST**

EACH STEEL FRAMED VINYL GATE KIT INCLUDES:

- A. Steel Framed Vinyl Gate (1)
- B. 1 ¾" Adjustable U-Hinge (1 set) or 2" U-Hinge for specialty gates
- C. Paddle Latch (1)
- D. 2-sided steel inserts (2) or 3-sided inserts for gates over 6'

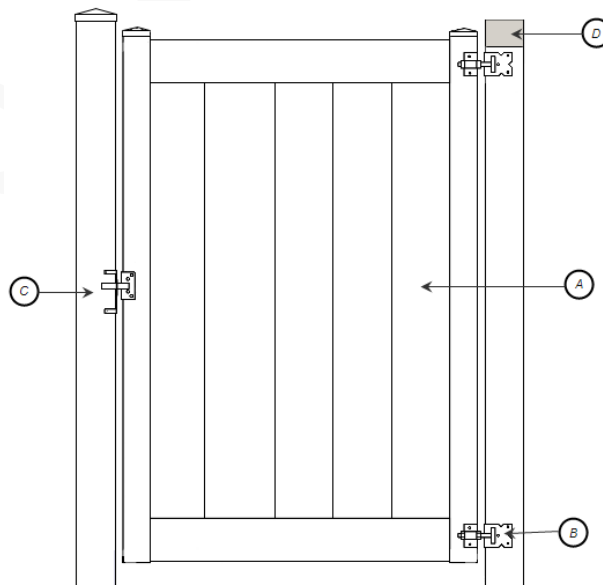

## PREPARE FENCE & GATE LAYOUT

**PLEASE READ ALL INSTRUCTION SHEETS COMPLETELY BEFORE BEGINNING WORK. LAYING OUT THE FENCE IS AN IMPORTANT FIRST STEP TOWARD A QUALITY INSTALLATION.**

### STEP 1

Locate your property lines

### STEP 2

Drive stakes into the ground just beyond where the posts are being placed and off center of the property line. Stretch a string from stake to stake.

**TIP:** Run string line 6"- 8" above the ground for less interference.

### STEP 3

Mark the location of each post hole. Locations should be 73" on center for 6' sections and 84" on center for 7' sections. Gate posts should be set at desired width for a custom gate or at the recommended width for a stock gate.

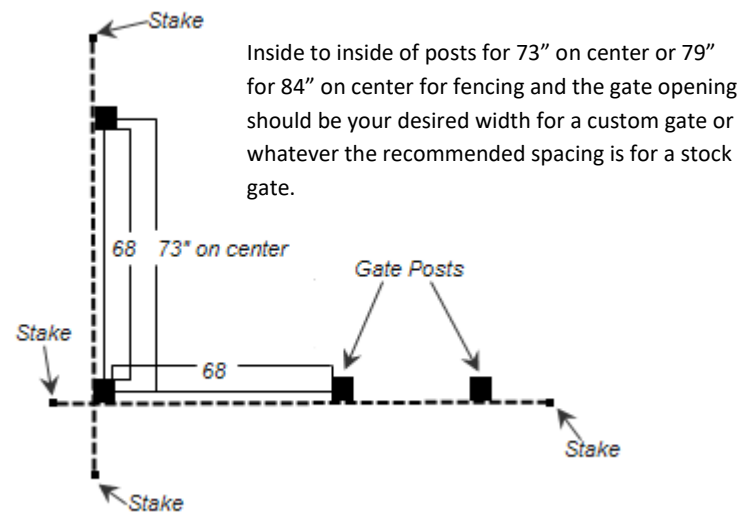

**NOTE:** If you don't have neighbors' approval to split the fence on the property line, run the string line on the property line. This will save you time and money.

## SETTING THE POSTS

### STEP 1

Dig holes approximately 8" - 10" in diameter and 24" deep, for hinge posts Dig 10"-12" in diameter. This will allow you to put more concrete in the hole and will make the post more solid.

### STEP 2

Place the post in the center of the hole and square it up with the fence line. Check the post on two adjacent sides with a level or use a post level to check for plumb. You will adjust for the height of the fence at this time. It is recommended that you set the posts 72" from the ground to the top of the post.

### STEP 3

Pour concrete around posts and fill up to 2" below ground level. If using mixed concrete make sure it's only slightly wet this will allow for a faster set up and less chance of the post leaning due to wind. If using dry concrete dump a 1/3 of the bag in the hole and mix with some water repeat this step until filled. Follow these steps until all posts are set and are ready for panel installation.

**TIP:** An extra person will make setting posts not only easier but faster as well.

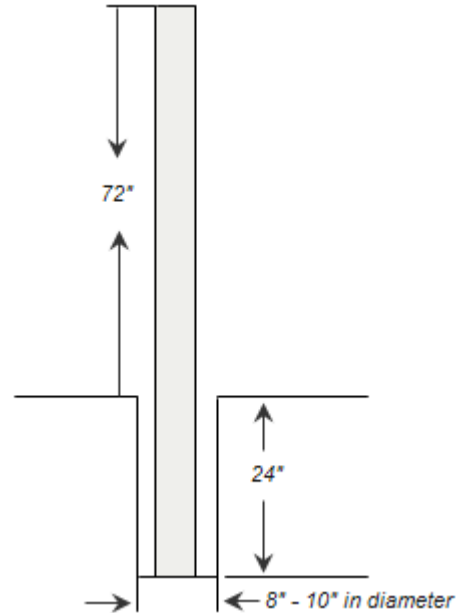

**NOTE:** Let the posts set up for at least 4 – 7 days to ensure proper hardening of concrete.

## INSTALL INSERTS

There are two ways to install the insert. The first (A) is to slide the insert into the post and secure it at the bottom with a self tapping screw. Then set the post like normal making sure that the insert is placed in the right position. The second (B) would be to slide it into the post after it is set. Slide the insert into the top of the post and slowly lower into the post. Make sure that the insert is turned the right way so that the hinge screws and the latch screws will grab steel. This provides the greatest strength point for the hinges and latch to be attached.

**CAUTION: INSERTS HAVE SHARP EDGES  
GLOVES ARE RECOMMENDED FOR HANDLING.**

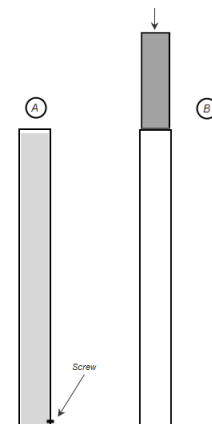

**INSTALL INSERTS CONTINUED**

*Always place the corner of the insert on the inside face of which direction the gate is swinging.*

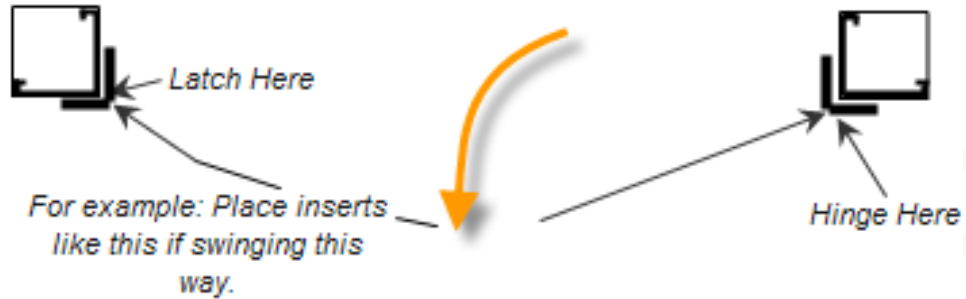

**ATTACHING HINGES TO GATE**

Locate the **Place Hinge Here** sticker on the end of the gate and attach the hinges using the self tapping screws that are provided. Place the hinges in-line with the rails as shown in the picture to the right.

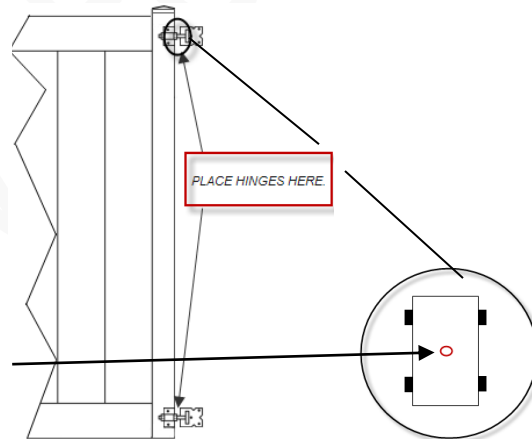

DO NOT PLACE A SCREW ON THE END OF THE HINGE.  
(Indicated by the red circle)  
DOING THIS GIVES YOU LESS ROOM FOR ADJUSTMENTS LATER.

**INSTALL GATE**

**STEP 1**

Use a block or piece of wood to prop up the gate into desired position, or have someone hold the gate in the desired position.

**STEP 2**

Screw the hinges with gate attached to the post with the self tapping screws that are provided.

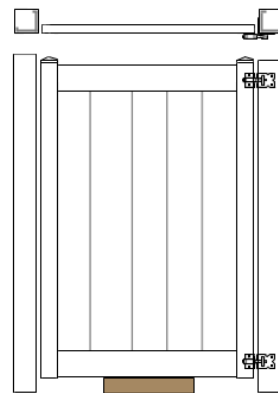

**NOTE: Make sure hinges are lined up correctly.**

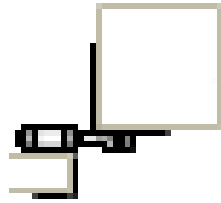

**INCORRECT**

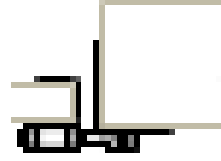

**CORRECT**

### ADJUSTING THE GATE

Adjust the gate by turning the nuts on the hinges until the approximate spacing on each side is 1". Sometimes adjustments can vary so go with what works best.

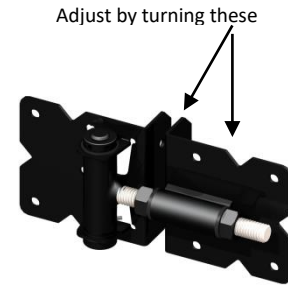
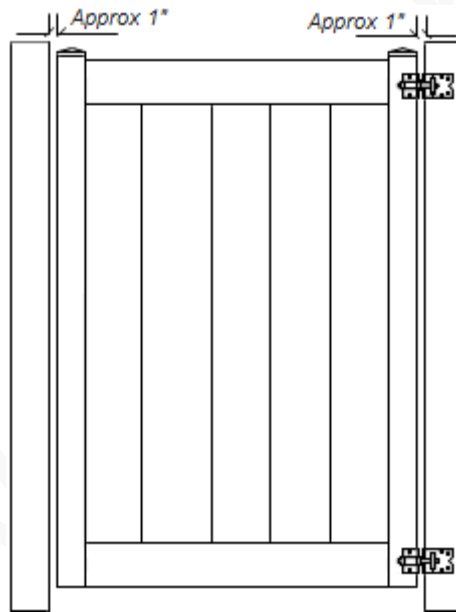

### ATTACHING THE LATCH

**STEP 1**

Attach the striker pin to the gate using the self tapping screws that are provided. Recommended height is about 42" to 48".

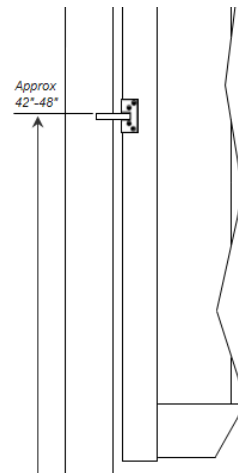

## ATTACHING THE LATCH CONTINUED

### STEP 2

Place the latch around the striker pin (A) and then position the latch so that the striker sits in the latch without touching the top or bottom (B). Attach the latch with the self tapping screws provided.

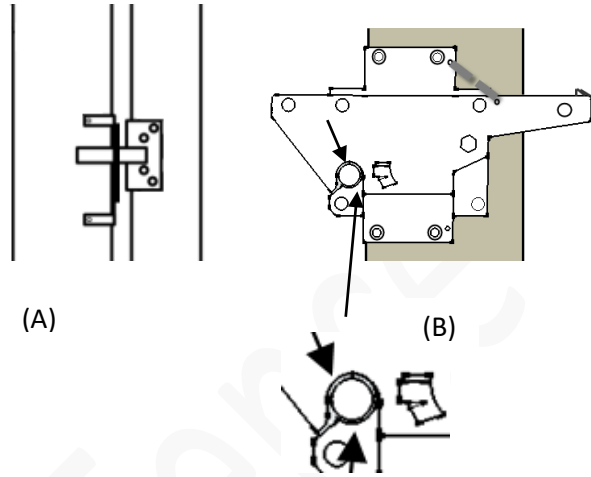

### STEP 3

Swing the gate open and closed a few times to check for proper alignment. If adjustments are needed do them now, if not, move on to next step.

## POST CAPS

Apply a small amount of PVC glue to the inner rim of the cap and place onto the post. Make sure the cap is firmly in place.

*TIP: Place only one or two dots of glue this is sufficient for holding the cap on and will allow removal if needed.*

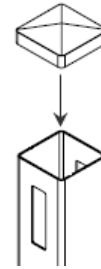

## CLEANING

During installation your fence will collect some vinyl residue and dirt due to static electricity and basic installation procedures. In most cases you can spray this off with a hose. However for more stubborn marks you can use some Simple Green cleaner with a non-abrasive Scotch Brite pad. This is also the best thing to use for cleaning your fence in the future.

For more information contact:

US VINYL FENCE  
— Fence, Deck and Rail —

801-262-6428

1333 W 9000 S, West Jordan, UT 84088

E-mail: [sales@usvinylfence.com](mailto:sales@usvinylfence.com) \* [www.usvinylfence.com](http://www.usvinylfence.com)