

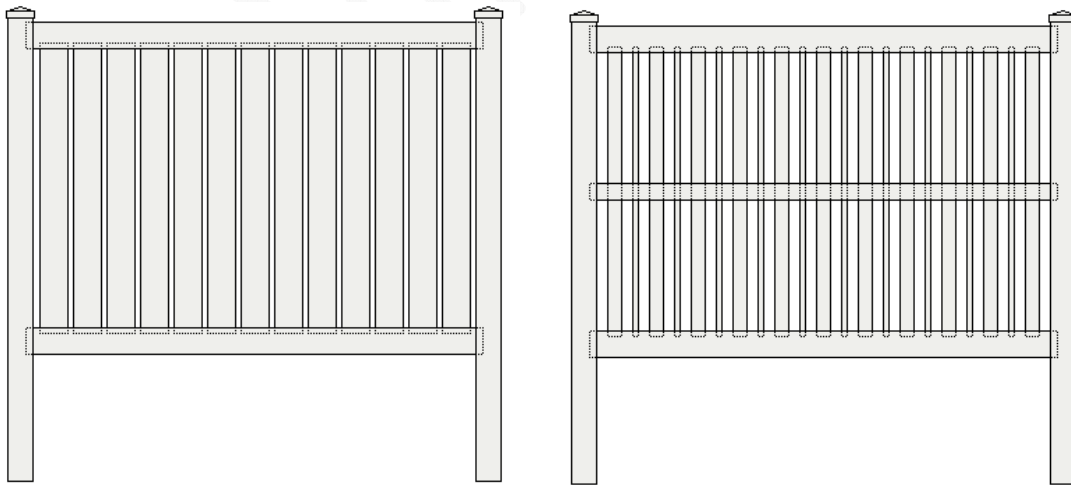

US VINYL FENCE
— Fence, Deck and Rail —

SEMI-PRIVACY

INSTALLATION INSTRUCTIONS



WHAT YOU'LL NEED TO INSTALL

- POWER AUGER OR POST HOLE DIGGER (CLAMSHELLS)
- SHOVEL
- DIGGING BAR (OPTIONAL)
- BRIGHT COLORED SPRAY PAINT
- STRING LINE STAKES AND LEVEL
- CORDLESS OR POWER DRILL WITH DRILL AND SCREW BITS
- TAPE MEASURE
- SAFETY GLASSES AND WORK GLOVES
- CHOP SAW OR CIRCULAR SAW TO CUT RAILS (IF APPLICABLE)
- TABLESAW OR CIRCULAR SAW TO CUT PICKETS (TABLE SAW RECOMMENDED)
- PVC ADHESIVE
- RAG AND CLEANER



HELPFULL HINTS

- TO ENSURE PROPER POST SPACING, MAKE A JIG MEASURING 92" LONG FROM A WOOD 2 X 4.
- SET ALL CORNER, END AND GATE POSTS FIRST FOR PROPER ALIGNMENT. THIS ALSO ALLOWS YOU TO GET THE HEIGHT ON ALL POSTS PRECISE, BY RUNNING A STRING LINE FROM POST TOP TO POST TOP.

FOLLOW THESE IMPORTANT STEPS BEFORE YOU START:

- Locate property lines... You can find these by locating a pin placed in the curb in the front of your house or by a stake buried in the ground or by a T post placed in the back. If you can't find any of these then try and locate a plot map. Otherwise you will have to hire a surveyor to locate your property lines.
- Check your local city codes regarding fence locations in the front of the house some cities may restrict you to a 3' or 4' height limit also check for overall fence heights in your city. A permit may be required for fences that exceed 6' in height.
- If you live in an HOA make sure to have your fence color and height approved before installing. This will save you money and possibly delays.

Contact Blue Stakes for location of utilities and pipelines. "It's The Law"

CALL 811 OR 1-800-662-4111

Semi-Privacy Panel

PARTS LIST

Each 3', 4', 5' & 6' HIGH SEMI-PRIVACY PANEL INCLUDES:

- A. 1 1/2" x 5 1/2" Routed Rails (2)
- B. 3/4" x 5 3/4" Ribbed Pickets (13)
- C. Steel Insert (1) for use with 8' sections

Each 3', 4', 5' & 6' HIGH ALTERNATING SEMI-PRIVACY INCLUDES:

- A. 1 1/2" x 5 1/2" Routed Rails (2)
- B. 1 3/4" x 3 1/2" Routed Rail (1)
- C. 7/8" x 3" Pickets (11)
- D. 3/4" x 1 1/2" Pickets (10)
- E. Steel Insert (1) for use with 8' sections

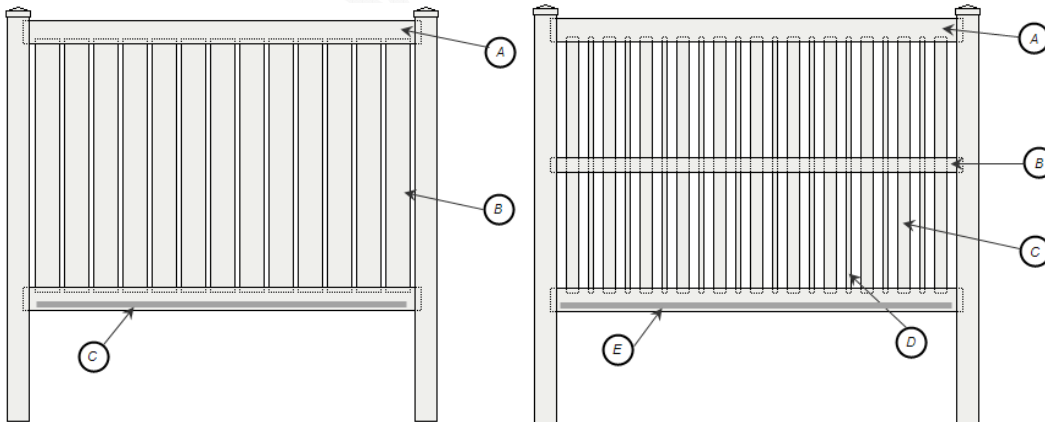

PREPARE FENCE LAYOUT

PLEASE READ THIS INSTRUCTION SHEET COMPLETELY BEFORE BEGINNING WORK. LAYING OUT THE FENCE IS AN IMPORTANT FIRST STEP TOWARD A QUALITY INSTALLATION.

STEP 1

Locate your property lines

STEP 2

Drive stakes into the ground just beyond where the posts are being placed and off center of the property line. Stretch a string from stake to stake.

TIP: Run string line 6"- 8" above the ground for less interference.

STEP 3

Mark the location of each post hole. Locations should be 73" on center for 6' sections and 97" on center for 8' sections.

TIP: Use spray paint to mark hole locations.

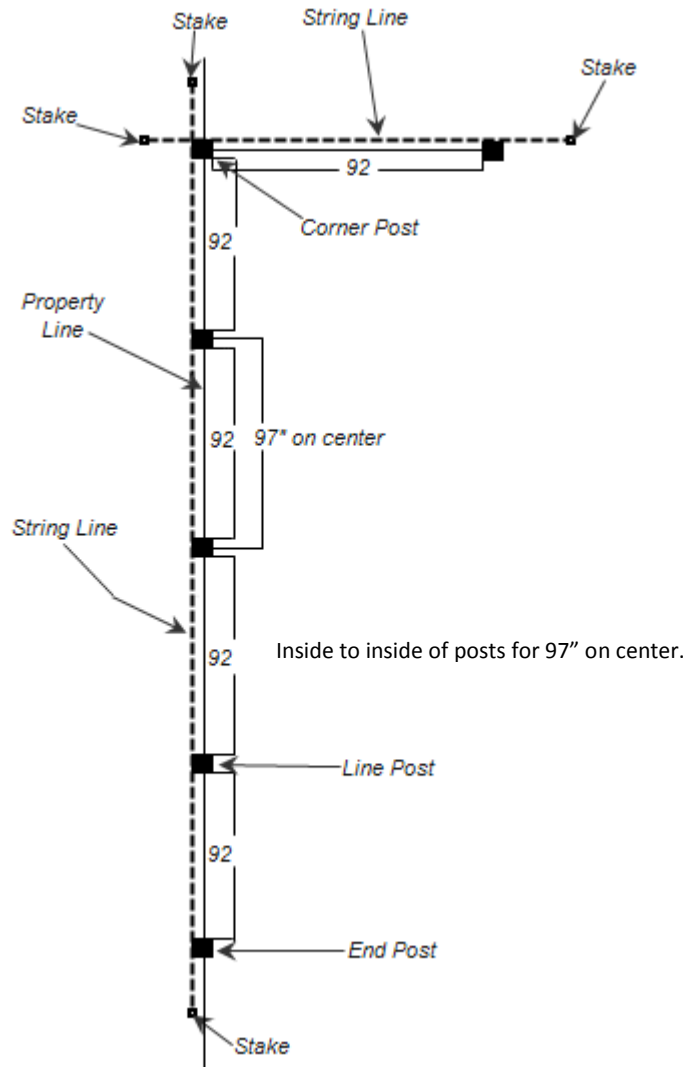

NOTE: If you don't have neighbors' approval to split the fence on the property line, run the string line on the property line. This will save you time and money.

SETTING THE POSTS

STEP 1

Dig holes approximately 8" - 10" in diameter and 24" deep.

STEP 2

Place the post in the center of the hole and square it up with the fence line. Check the post on two adjacent sides with a level or use a post level to check for plumb. You will adjust for the height of the fence at this time. It is recommended that you set the post 2" from the bottom of the bottom rail to the ground.

STEP 3

Pour concrete around posts and fill up to 2" below ground level. If using mixed concrete make sure it's only slightly wet this will allow for a faster set up and less chance of the post leaning due to wind. If using dry concrete dump a 1/3 of the bag in the hole and mix with some water repeat this step until filled. Follow these steps until all posts are set and are ready for panel installation.

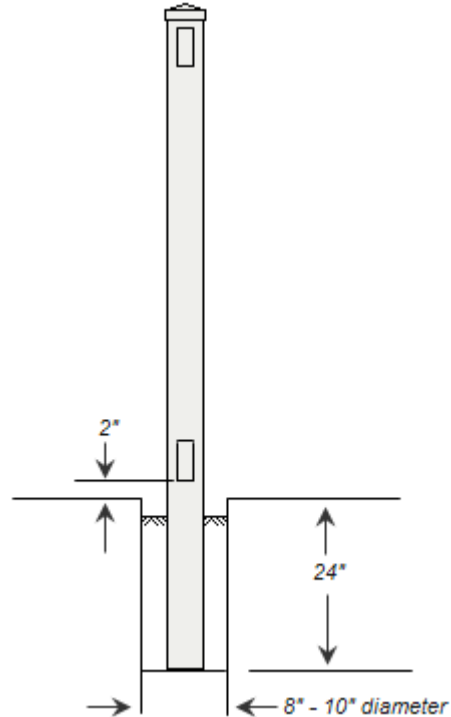

NOTE: Let the posts set up for at least 4 – 7 days to ensure proper hardening of concrete.

TIP: An extra person will make setting posts not only easier but faster as well.

PANEL ASSEMBLY – BOTTOM RAIL

STEP 1

Slide bottom rail into the post. The notches on the rail will lock the rail into the post. If your rails come un-notched you can either rent a notching tool or secure the rails with screws. Most U.S. Vinyl Fence picket sections are custom fit. If you have to cut the rails make sure to cut the same amount off of each end and cut them 3" longer than your post to post measurement this will allow for proper inset.

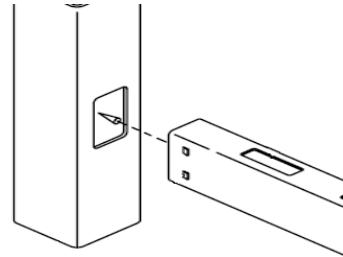

PANEL ASSEMBLY – PICKETS

STEP 1

Starting at one end, insert the pickets into the bottom rail and move down the panel. Move on to the next step.

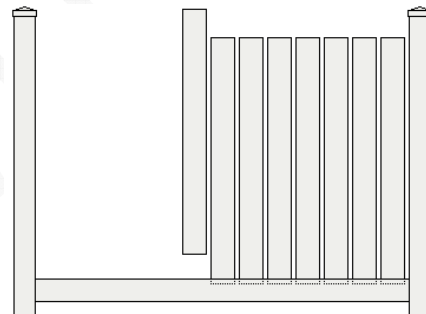

PANEL ASSEMBLY TOP RAIL

STEP 1

Put the top rail on an angle and place onto the picket. Slide the rail into the post. Lower the rail onto remaining pickets. When fully down slide rail into opposite post.

NOTE: If your rails don't come pre-notched you can rent a notching tool or use screws to secure the rail.

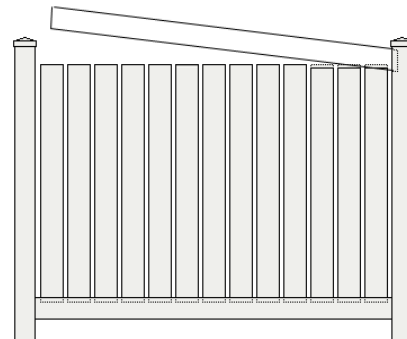

A diagram on HOW TO secure rails with screws is on page 6.

POST CAPS

Apply a small amount of PVC glue to the inner rim of the cap and place onto the post. Make sure the cap is firmly in place.

TIP: Place only one or two dots of glue this is sufficient for holding the cap on and will allow removal if needed.

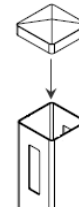

CLEANING

During installation your fence will collect some vinyl residue and dirt due to static electricity and basic installation procedures. In most cases you can spray this off with a hose. However for more stubborn marks you can use some Simple Green cleaner with a non-abrasive Scotch Brite pad. This is also the best thing to use for cleaning your fence in the future.

SECURING RAILS WITH SCREWS

STEP 1

To secure bottom rail screw a screw into the wall of the rail at an angle towards the long end of the rail. This will act as a notch and will securely hold the rail in place.

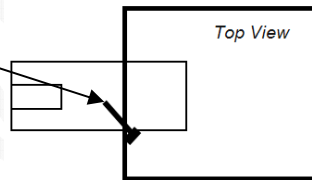

BOTTOM RAIL

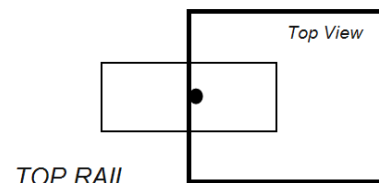

TOP RAIL

STEP 2

To secure the top rail just screw a screw into the top rail next to the post at an angle. This will securely hold the rail in place and will make removal easier if necessary.

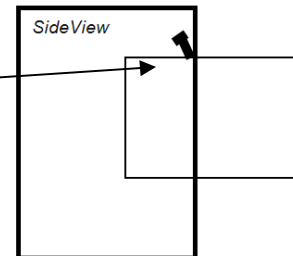
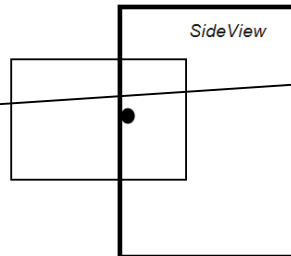

For more information contact:

US VINYL FENCE
— Fence, Deck and Rail —

801-262-6428

1-800-666-2467 (toll-free)

249 W Vine Street Murray, UT 84107

E-mail: sales@usvinylfence.com * www.usvinylfence.com